

Herts for Learning Primary Maths Team
model written calculations policy

Rationale

This policy outlines a model progression through written strategies for addition, subtraction, multiplication and division in line with the new National Curriculum commencing September 2014. Through the policy, we aim to link key manipulatives and representations in order that the children can be vertically accelerated through each strand of calculation. We know that school wide policies, such as this, can ensure consistency of approach, enabling children to progress stage by stage through models and representations they recognise from previous teaching, allowing for deeper conceptual understanding and fluency. As children move at the pace appropriate to them, teachers will be presenting strategies and equipment appropriate to children's level of understanding. However, it is expected that the majority of children in each class will be working at age-appropriate levels as set out in the National Curriculum 2014 and in line with school policy.

The importance of mental mathematics

While this policy focuses on written calculations in mathematics, we recognise the importance of the mental strategies and known facts that form the basis of all calculations. The following checklists outline the key skills and number facts that children are expected to develop throughout the school.

To add and subtract successfully, children should be able to:

- recall all addition pairs to $9 + 9$ and number bonds to 10
- recognise addition and subtraction as inverse operations
- add mentally a series of one digit numbers (e.g. $5 + 8 + 4$)
- add and subtract multiples of 10 or 100 using the related addition fact and their knowledge of place value (e.g. $600 + 700$, $160 - 70$)
- partition 2 and 3 digit numbers into multiples of 100, 10 and 1 in different ways (e.g. partition 74 into $70 + 4$ or $60 + 14$)
- use estimation by rounding to check answers are reasonable

To multiply and divide successfully, children should be able to:

- add and subtract accurately and efficiently
- recall multiplication facts to $12 \times 12 = 144$ and division facts to $144 \div 12 = 12$
- use multiplication and division facts to estimate how many times one number divides into another etc.
- know the outcome of multiplying by 0 and by 1 and of dividing by 1
- understand the effect of multiplying and dividing whole numbers by 10, 100 and later 1000
- recognise factor pairs of numbers (e.g. that $15 = 3 \times 5$, or that $40 = 10 \times 4$) and increasingly able to recognise common factors
- derive other results from multiplication and division facts and multiplication and division by 10 or 100 (and later 1000)
- notice and recall with increasing fluency inverse facts
- partition numbers into 100s, 10s and 1s or multiple groupings
- understand how the principles of commutative, associative and distributive laws apply or do not apply to multiplication and division
- understand the effects of scaling by whole numbers and decimal numbers or fractions
- understand correspondence where n objects are related to m objects
- investigate and learn rules for divisibility

Progression in addition and subtraction

Addition and subtraction are connected.

Part	Part
Whole	

Addition names the whole in terms of the parts and **subtraction** names a missing part of the whole.

Addition

Combining two sets (aggregation)

Putting together – two or more amounts or numbers are put together to make a total
 $7 + 5 = 12$

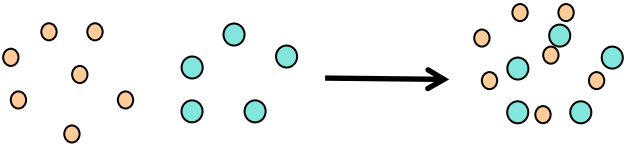

Count one set, then the other set. Combine the sets and count again. Starting at 1.

Counting along the bead bar, count out the 2 sets, then draw them together, count again. Starting at 1.



Subtraction

Taking away (separation model)

Where one quantity is taken away from another to calculate what is left.

$$7 - 2 = 5$$

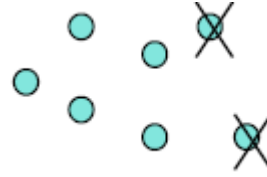

Multilink towers - to physically take away objects.

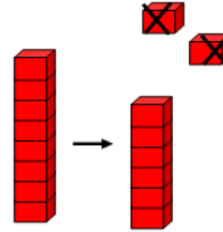

Combining two sets (augmentation)

This stage is essential in starting children to calculate rather than counting

Where one quantity is increased by some amount. Count on from the total of the first set, e.g. put 3 in your head and count on 2. Always start with the largest number.

Counters:

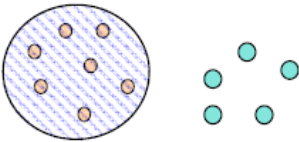

Start with 7, then count on 8, 9, 10, 11, 12

Bead strings:

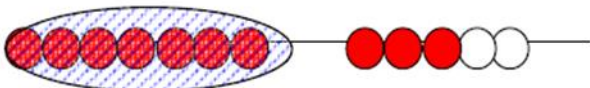

Make a set of 7 and a set of 5. Then count on from 7.

Finding the difference (comparison model)

Two quantities are compared to find the difference.

$$8 - 2 = 6$$

Counters:

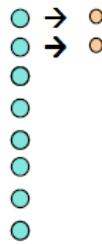

Bead strings:

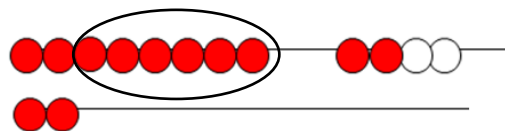

Make a set of 8 and a set of 2. Then count the gap.

Multilink Towers:



Cuisenaire Rods:

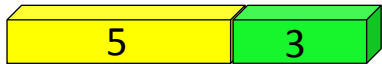
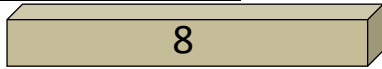

Number tracks:



Start on 5 then count on 3 more

Multilink Towers:

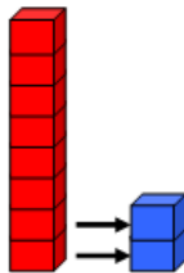

Cuisenaire Rods:

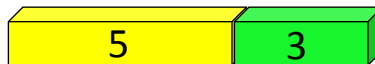
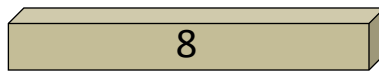

Number tracks:



Start with the smaller number and count the gap to the larger number.

1 set within another (part-whole model)

The quantity in the whole set and one part are known, and may be used to find out how many are in the unknown part.

$$8 - 2 = 6$$

Counters:



Bead strings:

$$8 - 2 = 6$$



Bridging through 10s

This stage encourages children to become more efficient and begin to employ known facts.

Bead string:

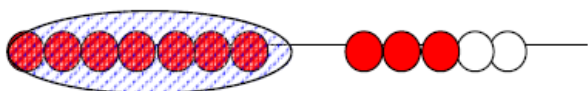

$7 + 5$ is decomposed / partitioned into $7 + 3 + 2$. The bead string illustrates 'how many more to the next multiple of 10?' (children should identify how their number bonds are being applied) and then 'if we have used 3 of the 5 to get to 10, how many more do we need to add on? (ability to decompose/partition all numbers applied)

Number track:



Steps can be recorded on a number track alongside the bead string, prior to transition to number line.

Number line

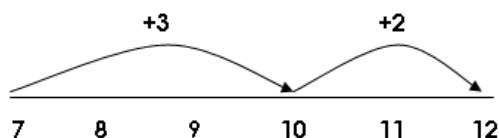

Bead string:



$12 - 7$ is decomposed / partitioned in $12 - 2 - 5$. The bead string illustrates 'from 12 how many to the last/previous multiple of 10?' and then 'if we have used 2 of the 7 we need to subtract, how many more do we need to count back? (ability to decompose/partition all numbers applied)

Number Track:

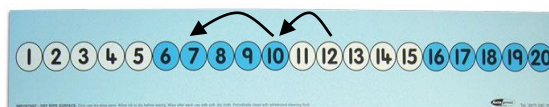

Steps can be recorded on a number track alongside the bead string, prior to transition to number line.

Number Line:

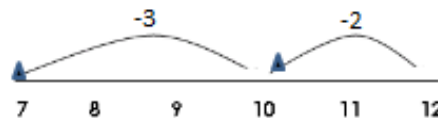

Counting up or 'Shop keepers' method

Bead string:



$12 - 7$ becomes $7 + 3 + 2$. Starting from 7 on the bead string 'how many more to the next multiple of 10?' (children should recognise how their number bonds are being applied), 'how many more to get to 12?'

Number Track:

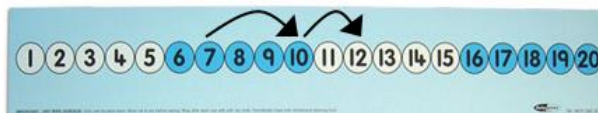

Number Line:

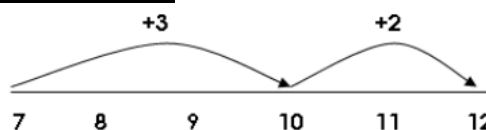

Compensation model (adding 9 and 11) (optional)

This model of calculation encourages efficiency and application of known facts (how to add ten)

$7 + 9$

Bead string:

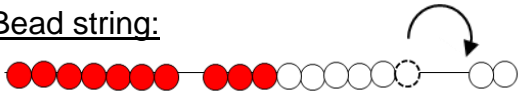

Children find 7, then add on 10 and then adjust by removing 1.

Number line:

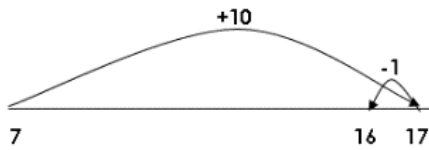

$18 - 9$

Bead string:



Children find 18, then subtract 10 and then adjust by adding 1.

Number line:

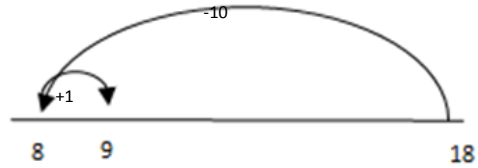

Working with larger numbers
Tens and ones + tens and ones

Ensure that the children have been transitioned onto Base 10 equipment and understand the abstract nature of the single 'tens' sticks and 'hundreds' blocks

Partitioning (Aggregation model)

$34 + 23 = 57$

Base 10 equipment:



Children create the two sets with Base 10 equipment and then combine; ones with ones, tens with tens.

Partitioning (Augmentation model)

Base 10 equipment:

Encourage the children to begin counting from the first set of ones and tens, avoiding counting from 1. Beginning with the ones in preparation for formal columnar method.

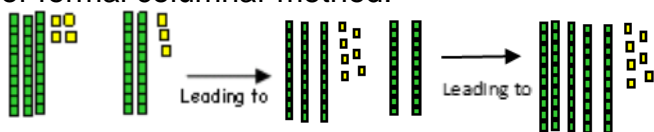

Number line:

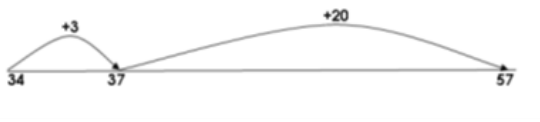

At this stage, children can begin to use an informal method to support, record and explain their method. (optional)

$$30 + 4 + 20 + 3$$

Take away (Separation model)

$57 - 23 = 34$

Base 10 equipment:

Children remove the lower quantity from the larger set, starting with the ones and then the tens. In preparation for formal decomposition.

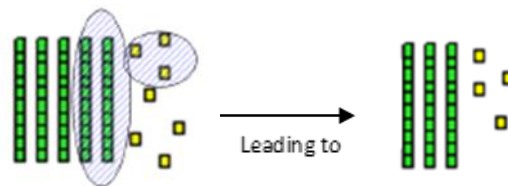

Number Line:

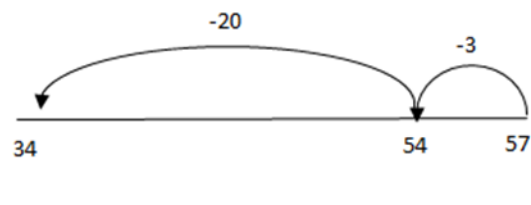

At this stage, children can begin to use an informal method to support, record and explain their method (optional)

$$(50 + 7) - (20 + 3)$$

Bridging with larger numbers

Once secure in partitioning for addition, children begin to explore exchanging. What happens if the ones are greater than 10? Introduce the term 'exchange'. Using the Base 10 equipment, children exchange ten ones for a single tens rod, which is equivalent to crossing the tens boundary on the bead string or number line.

Base 10 equipment:

$$37 + 15 = 52$$

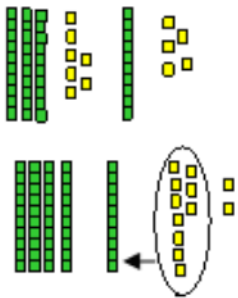

Discuss counting on from the larger number irrespective of the order of the calculation.

Base 10 equipment:

$$52 - 37 = 15$$

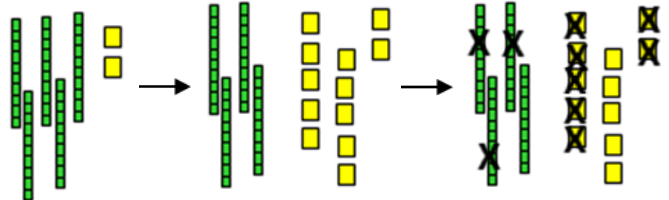

Expanded Vertical Method (optional)

Children are then introduced to the expanded vertical method to ensure that they make the link between using Base 10 equipment, partitioning and recording using this expanded vertical method.

Base 10 equipment:

$$67 + 24 = 91$$

67	60 + 7
+ 24	20 + 4
11	7 + 4
80	60 + 20
91	

Base 10 equipment:

$$91 - 67 = 24$$

80	11
90	+ 4
- 60	+ 7
20	+ 4

Compact method

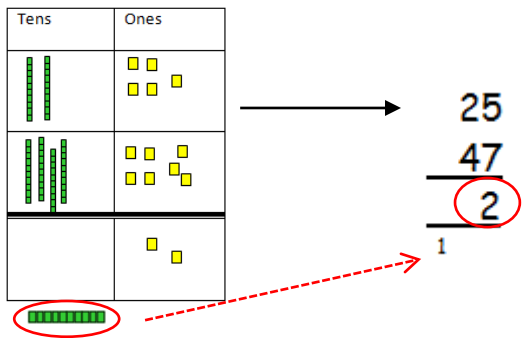

Leading to

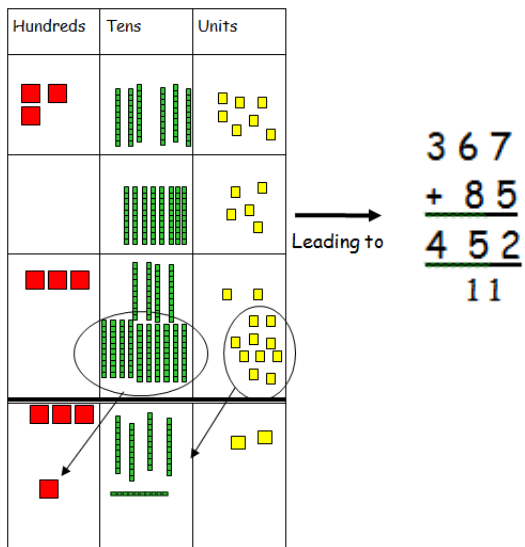
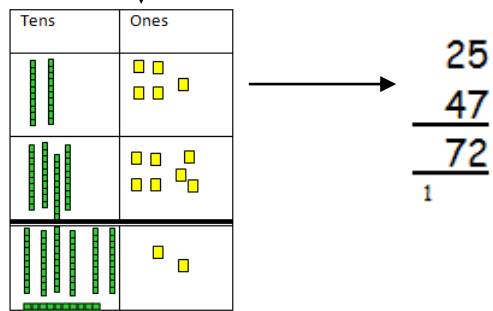

Compact decomposition

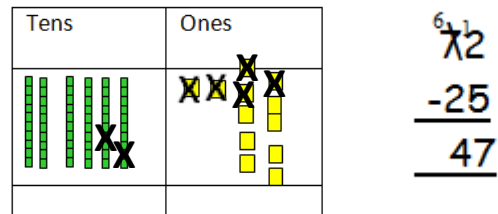
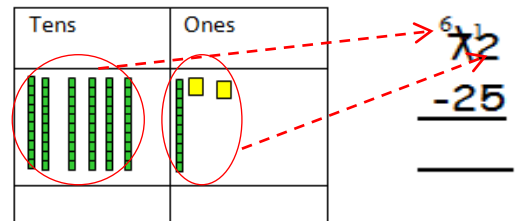
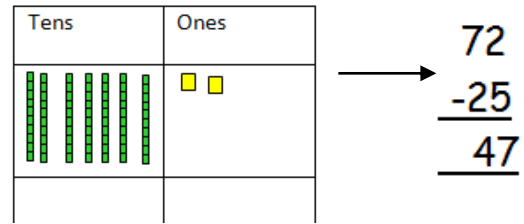

Vertical acceleration

By returning to earlier manipulative experiences children are supported to make links across mathematics, encouraging 'If I know this...then I also know...' thinking.

Decimals

Ensure that children are confident in counting forwards and backwards in decimals – using bead strings to support.

Bead strings:



Each bead represents 0.1, each different block of colour equal to 1.0

Base 10 equipment:

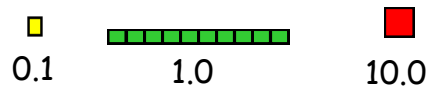

Addition of decimals

Aggregation model of addition

Counting both sets – starting at zero.

$$0.7 + 0.2 = 0.9$$

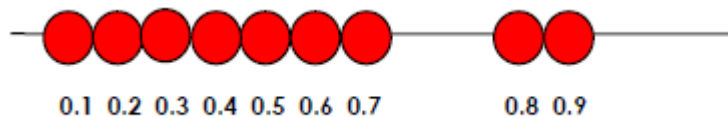

Augmentation model of addition

Starting from the first set total, count on to the end of the second set.

$$0.7 + 0.2 = 0.9$$

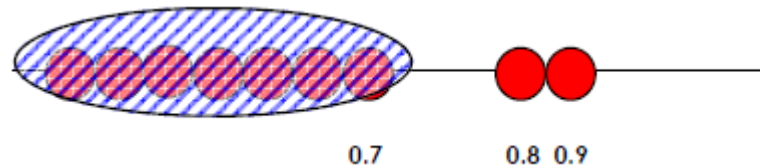

Bridging through 1.0

Encouraging connections with number bonds.

$$0.7 + 0.5 = 1.2$$



Partitioning

$$3.7 + 1.5 = 5.2$$

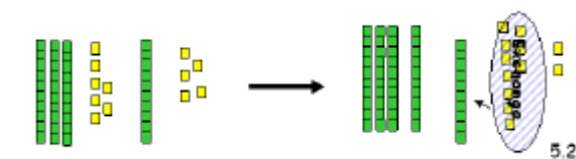

Subtraction of decimals

Take away model

$$0.9 - 0.2 = 0.7$$



Finding the difference (or comparison model):

$$0.8 - 0.2 =$$



Bridging through 1.0

Encourage efficient partitioning.

$$1.2 - 0.5 = 1.2 - 0.2 - 0.3 = 0.7$$



Partitioning

$$5.7 - 2.3 = 3.4$$

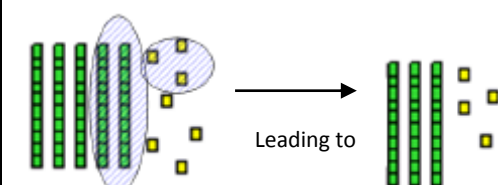

Gradation of difficulty- addition:

Gradation of difficulty- subtraction:

<ol style="list-style-type: none"> 1. No exchange 2. Extra digit in the answer 3. Exchanging ones to tens 4. Exchanging tens to hundreds 5. Exchanging ones to tens and tens to hundreds 6. More than two numbers in calculation 7. As 6 but with different number of digits 8. Decimals up to 2 decimal places (same number of decimal places) 9. Add two or more decimals with a range of decimal places 	<ol style="list-style-type: none"> 1. No exchange 2. Fewer digits in the answer 3. Exchanging tens for ones 4. Exchanging hundreds for tens 5. Exchanging hundreds to tens and tens to ones 6. As 5 but with different number of digits 7. Decimals up to 2 decimal places (same number of decimal places) 8. Subtract two or more decimals with a range of decimal places
---	--

Multiplication and division are connected.
Both express the relationship between a number of equal parts and the whole.

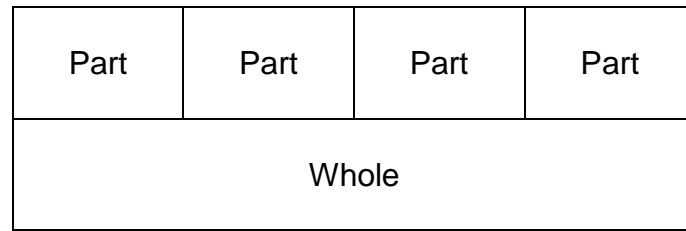

The following array, consisting of four columns and three rows, could be used to represent the number sentences: -

$$3 \times 4 = 12,$$

$$4 \times 3 = 12,$$

$$3 + 3 + 3 + 3 = 12,$$

$$4 + 4 + 4 = 12.$$

And it is also a model for division

$$12 \div 4 = 3$$

$$12 \div 3 = 4$$

$$12 - 4 - 4 - 4 = 0$$

$$12 - 3 - 3 - 3 - 3 = 0$$

Multiplication	Division
-----------------------	-----------------

Early experiences

Children will have real, practical experiences of handling equal groups of objects and counting in 2s, 10s and 5s. Children work on practical problem solving activities involving equal sets or groups.



Children will understand equal groups and share objects out in play and problem solving. They will count in 2s, 10s and 5s.



Repeated addition (repeated aggregation)

3 times 5 is $5 + 5 + 5 = 15$ or 5 lots of 3 or 5×3 . Children learn that repeated addition can be shown on a number line.

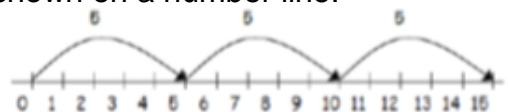

Children learn that repeated addition can be shown on a bead string.



Children also learn to partition totals into equal trains using Cuisenaire Rods

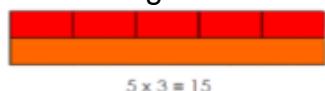

Sharing equally

6 sweets get shared between 2 people. How many sweets do they each get? A bottle of fizzy drink shared equally between 4 glasses.

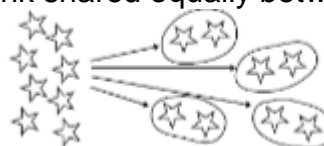

Grouping or repeated subtraction

There are 6 sweets. How many people can have 2 sweets each?



Scaling

This is an extension of augmentation in addition, except, with multiplication, we increase the quantity by a scale factor not by a fixed amount. For example, where you have 3 giant marbles and you swap each one for 5 of your friend's small marbles, you will end up with 15 marbles. This can be written as:

$$1 + 1 + 1 = 3 \quad \square \text{ scaled up by } 5 \quad \square 5 + 5 + 5 = 15$$

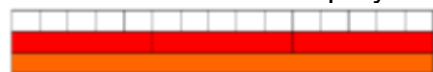

For example, find a ribbon that is 4 times as long as the blue ribbon.



We should also be aware that if we multiply by a number less than 1, this would correspond to a scaling that reduces the size of the quantity. For example, scaling 3 by a factor of 0.5 would reduce it to 1.5, corresponding to $3 \times 0.5 = 1.5$.

Repeated subtraction using a bead string or number line

$$12 \div 3 = 4$$

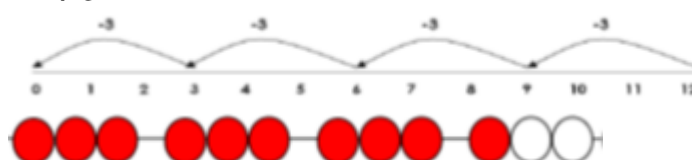

The bead string helps children with interpreting division calculations, recognising that $12 \div 3$ can be seen as 'how many 3s make 12?'

Cuisenaire Rods also help children to interpret division calculations.



Grouping involving remainders

Children move onto calculations involving

remainders.

13 ÷ 4 = 3 r1

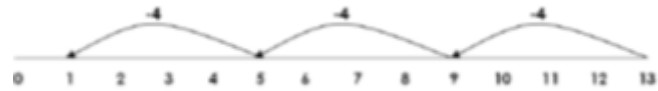

Or using a bead string see above.

Commutativity

Children learn that 3 x 5 has the same total as 5 x 3.

This can also be shown on the number line.

3 x 5 = 15

5 x 3 = 15

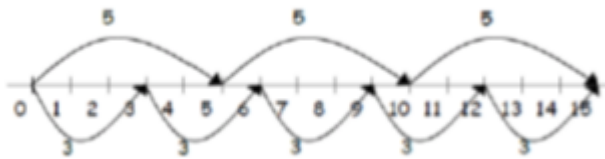

Children learn that division is **not** commutative and link this to subtraction.

Arrays

Children learn to model a multiplication calculation using an array. This model supports their understanding of **commutativity** and the development of the grid in a written method. It also supports the finding of factors of a number.

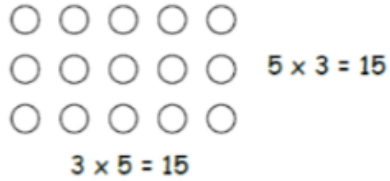

Children learn to model a division calculation using an array. This model supports their understanding of the development of partitioning and the 'bus stop method' in a written method. This model also connects division to **finding fractions** of discrete quantities.

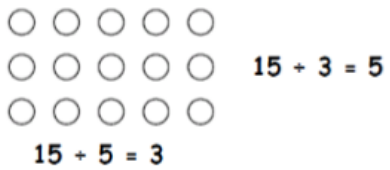

Inverse operations

Trios can be used to model the 4 related multiplication and division facts. Children learn to state the 4 related facts.

3 x 4 = 12

4 x 3 = 12

12 ÷ 3 = 4

12 ÷ 4 = 3

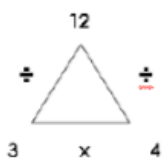

Children use symbols to represent unknown numbers and complete equations using inverse operations. They use this strategy to calculate the missing numbers in calculations.

□ x 5 = 20 3 x Δ = 18 O x □ = 32

24 ÷ 2 = □ 15 ÷ O = 3 Δ ÷ 10 = 8

This can also be supported using arrays: e.g. 3 X ? = 12

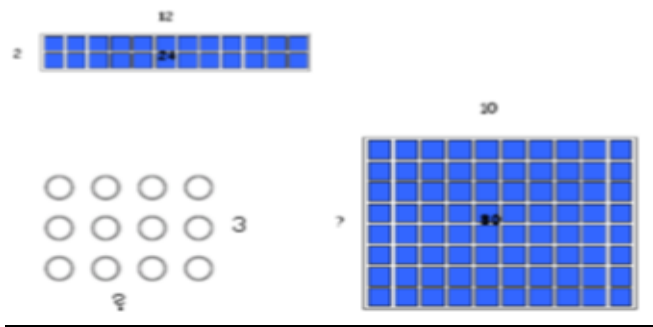

Partitioning for multiplication

Arrays are also useful to help children visualise how to partition larger numbers into more useful representation.

$$9 \times 4 = 36$$

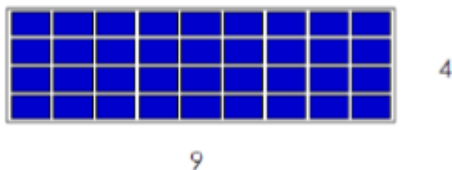

Children should be encouraged to be flexible with how they use number and can be encouraged to break the array into more manageable chunks.

$$9 \times 4 =$$

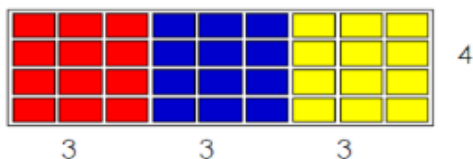

Which could also be seen as

$$9 \times 4 = (3 \times 4) + (3 \times 4) + (3 \times 4) = 12 + 12 + 12 = 36$$

$$\text{Or } 3 \times (3 \times 4) = 36$$

$$\text{And so } 6 \times 14 = (2 \times 10) + (4 \times 10) + (4 \times 6) = 20 + 40 + 24 = 84$$

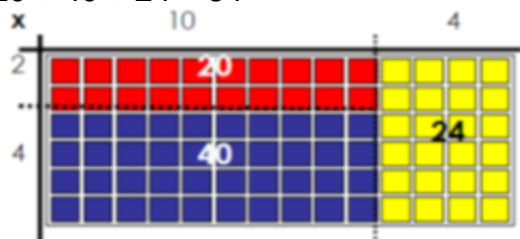

Partitioning for division

The array is also a flexible model for division of larger numbers

$$56 \div 8 = 7$$

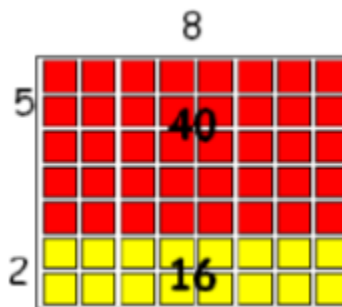

Children could break this down into more manageable arrays, as well as using their understanding of the inverse relationship between division and multiplication.

$$56 \div 8 = (40 \div 8) + (16 \div 8) = 5 + 2 = 7$$

To be successful in calculation learners must have plenty of experiences of being flexible with partitioning, as this is the basis of distributive and associative law.

Associative law

$$\text{E.g. } 3 \times (3 \times 4) = 36$$



The principle that if there are three numbers to multiply these can be multiplied in any order.

Distributive law (multiplication):-

$$\text{E.g. } 6 \times 14 = (2 \times 10) + (4 \times 10) + (4 \times 6) = 20 + 40 + 24 = 84$$

This law allows you to distribute a multiplication across an addition or subtraction.

Distributive law (division):-

$$\text{E.g. } 56 \div 8 = (40 \div 8) + (16 \div 8) = 5 + 2 = 7$$

This law allows you to distribute a division across an addition or subtraction.

(multiplication only) :-

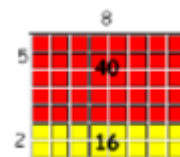
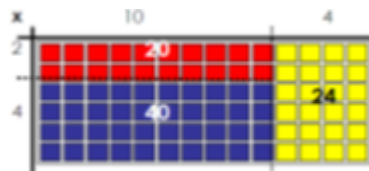

Arrays leading into the grid method

Children continue to use arrays and partitioning, where appropriate, to prepare them for the grid method of multiplication. Arrays can be represented as 'grids' in a shorthand version and by using place value counters to show multiples of ten, hundred etc.

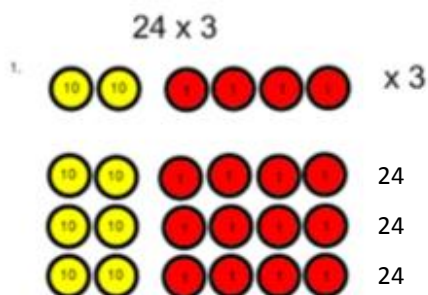

Arrays leading into chunking and then long and short division

Children continue to use arrays and partitioning where appropriate, to prepare them for the 'chunking' and short method of division. Arrays are represented as 'grids' as a shorthand version.

e.g. $78 \div 3 =$

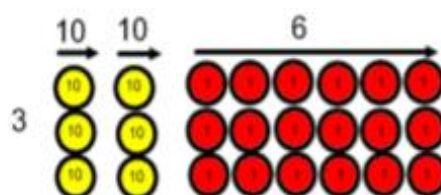

$$78 \div 3 = (30 \div 3) + (30 \div 3) + (18 \div 3) = 10 + 10 + 6 = 26$$

Grid method

This written strategy is introduced for the multiplication of TO x O to begin with. It may require column addition methods to calculate the total.

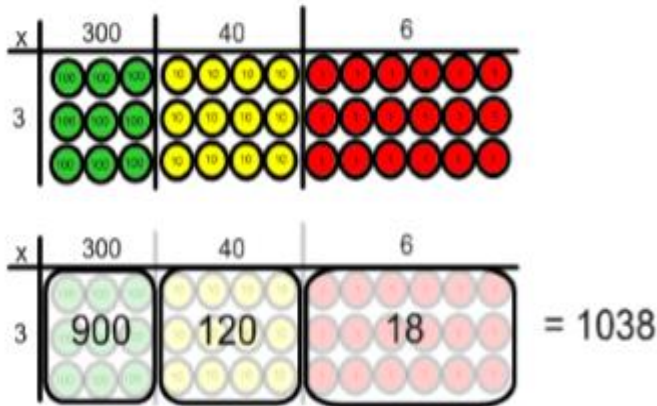

The vertical method- 'chunking' leading to long division

See above for example of how this can be modelled as an array using place value counters. $78 \div 3 =$

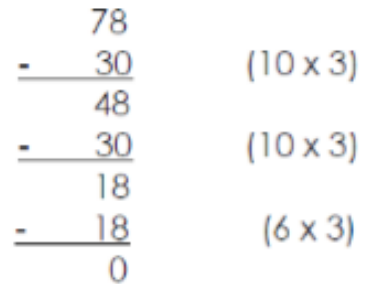

So $78 \div 3 = 10 + 10 + 6 = 26$

Short multiplication — multiplying by a single digit

The array using place value counters becomes the basis for understanding short multiplication first without exchange before moving onto exchanging

24×6

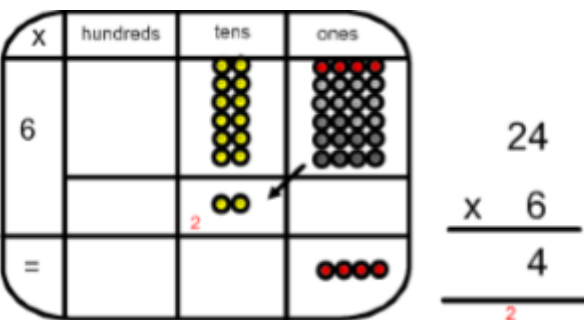
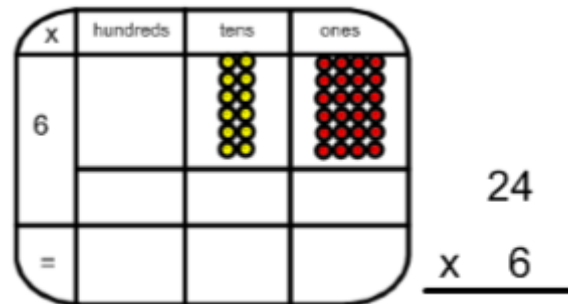

Short division — dividing by a single digit

Whereas we can begin to group counters into an array to show short division working $136 \div 4$

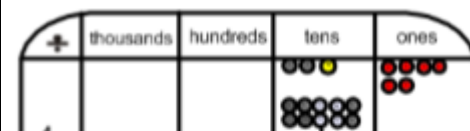
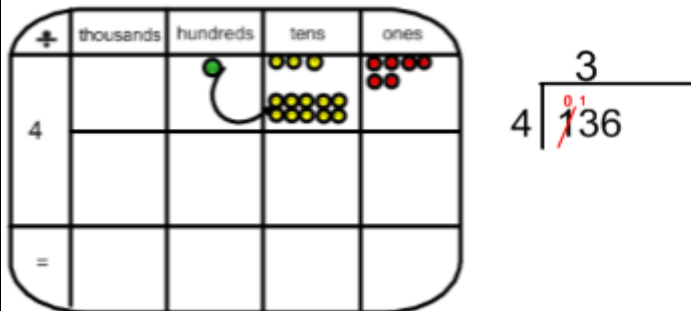

X	hundreds	tens	ones	
6		24		24
	1	2		x 6
=		44		44
				1 2

X	hundreds	tens	ones	
6		24		24
	1	2		x 6
=	100	40	4	144
				1 2

		34
4	136	

	30 + 4
4	120 + 16
	136

- Gradation of difficulty (short multiplication)**
1. TO x O no exchange
 2. TO x O extra digit in the answer
 3. TO x O with exchange of ones into tens
 4. HTO x O no exchange
 5. HTO x O with exchange of ones into tens
 6. HTO x O with exchange of tens into hundreds
 7. HTO x O with exchange of ones into tens and tens into hundreds
 8. As 4-7 but with greater number digits x O
 9. O.t x O no exchange
 10. O.t with exchange of tenths to ones
 11. As 9 - 10 but with greater number of digits which may include a range of decimal places x O

- Gradation of difficulty (short division)**
1. TO ÷ O no exchange no remainder
 2. TO ÷ O no exchange with remainder
 3. TO ÷ O with exchange no remainder
 4. TO ÷ O with exchange, with remainder
 5. Zero in the quotient e.g. $816 \div 4 = 204$
 6. As 1-5 HTO ÷ O
 7. As 1-5 greater number of digits ÷ O
 8. As 1-5 with a decimal dividend e.g. $7.5 \div 5$ or $0.12 \div 3$
 9. Where the divisor is a two digit number
- See below for gradation of difficulty with remainders

Dealing with remainders

Remainders should be given as integers, but children need to be able to decide what to do after division, such as rounding up or down accordingly.

e.g.:

- I have 62p. How many 8p sweets can I buy?
- Apples are packed in boxes of 8. There are 86 apples. How many boxes are needed?

Gradation of difficulty for expressing remainders

1. Whole number remainder
2. Remainder expressed as a fraction of the divisor
3. Remainder expressed as a simplified fraction
4. Remainder expressed as a decimal

Long multiplication—multiplying by more than one digit

Children will refer back to grid method by using place value counters or Base 10 equipment with no exchange and using synchronised modelling of written recording as a long multiplication model before moving to TO x TO etc.

Long division —dividing by more than one digit

Children should be reminded about partitioning numbers into multiples of 10, 100 etc. before recording as either:-

1. Chunking model of long division using Base 10 equipment
2. Sharing model of long division using place value counters

See the following pages for exemplification of these methods.

Chunking model of long division using Base 10 equipment

This model links strongly to the array representation; so for the calculation $72 \div 6 = ?$ - one side of the array is unknown and by arranging the Base 10 equipment to make the array we can discover this unknown. The written method should be written alongside the equipment so that children make links.

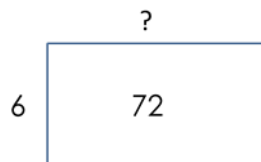

Begin with divisors that are between 5 and 9

$72 \div 6 = 12$

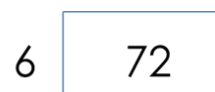

1. Make a rectangle where one side is 6 (the number dividing by) – grouping 6 tens

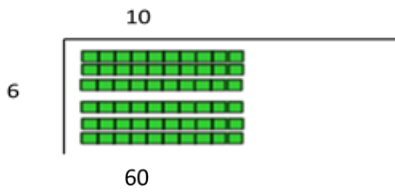

After grouping 6 lots of 10 (60) we have 12 left over



2. Exchange the remaining ten for ten ones

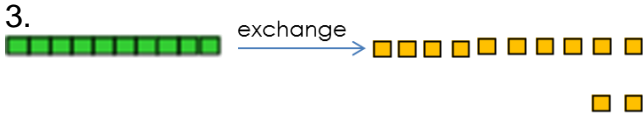

4. Complete the rectangle by grouping the remaining ones into groups of 6

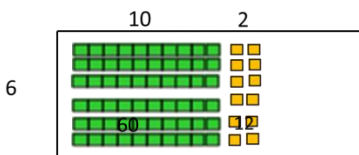

$$\begin{array}{r} 1 \\ 6 \overline{) 72} \\ \underline{- 60} \quad (10 \times) \\ 12 \end{array}$$

$$\begin{array}{r} 12 \\ 6 \overline{) 72} \\ \underline{- 60} \quad (10 \times) \\ 12 \\ \underline{- 12} \quad (2 \times) \\ 0 \end{array}$$

Move onto working with divisors between 11 and 19

Children may benefit from practise to make multiples of tens using the hundreds and tens and tens and ones.

$$289 \div 12$$

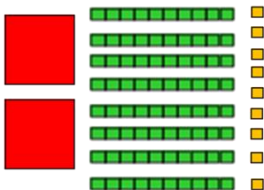

$$12 \overline{) 289}$$

1. Make a rectangle where one side is 12 (the number dividing by) using hundreds and tens

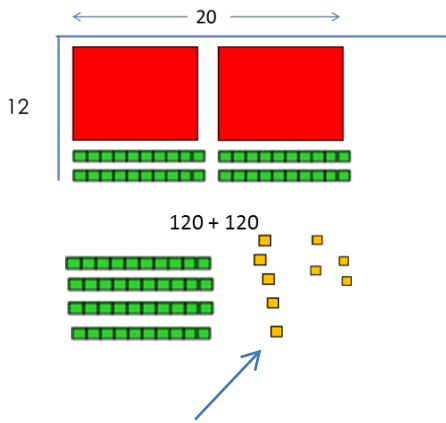

With 49 remaining

$$\begin{array}{r}
 2 \\
 12 \overline{) 289} \\
 \underline{- 240} \quad (20 \times) \\
 49
 \end{array}$$

2. Make groups of 12 using tens and ones

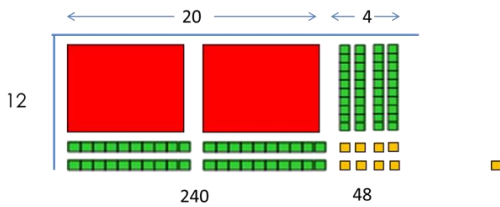

No more groups of 12 can be made and 1 remains

$$\begin{array}{r}
 24 \text{ r}1 \\
 12 \overline{) 289} \\
 \underline{- 240} \quad (20 \times) \\
 49 \\
 \underline{- 48} \quad (4 \times) \\
 1
 \end{array}$$

Sharing model of long division using place value counters

Starting with the most significant digit, share the hundreds. The writing in brackets is for verbal

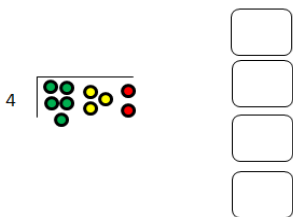

$$4 \overline{) 532}$$

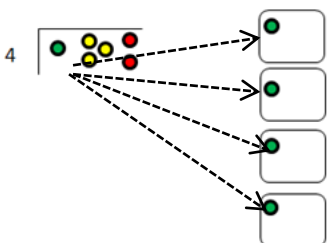

$$\begin{array}{r}
 1 \\
 4 \overline{) 532} \\
 \underline{- 4} \quad (4 \text{ hundreds used}) \\
 1 \quad (1 \text{ hundred left})
 \end{array}$$

ning 2014

Moving to tens – exchanging hundreds for tens means that we now have a total of 13 tens

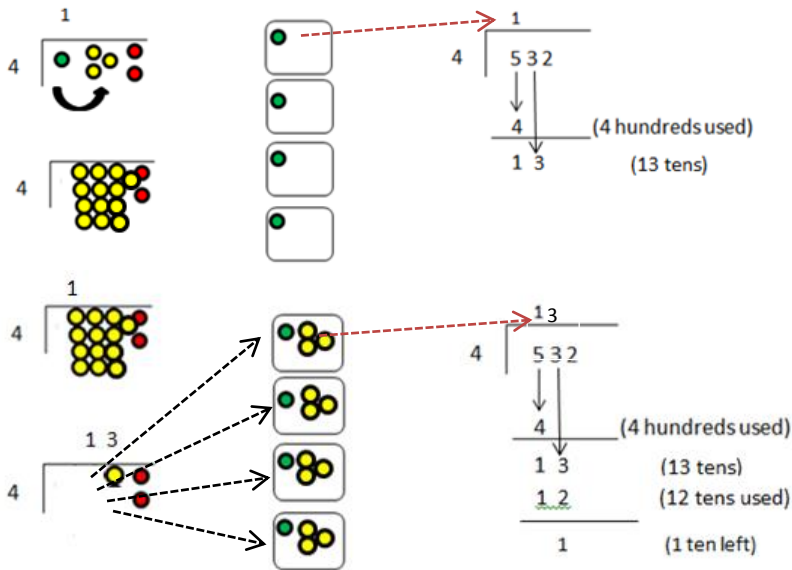

Moving to ones, exchange tens to ones means that we now have a total of 12 ones counters (hence the arrow)

